



DIRIS A80

Multifunction meters - PMD + RCM

monitoring energy and fault currents - dimensions 96 x 96 mm

Single-circuit metering,
measurement &
analysis



DIRIS A80

Function

DIRIS A80 is a complete panel mounted multifunction meter which incorporates RCM current monitoring (Residual Current Monitoring), for networks with TN-S and TT neutral systems, and enhanced data logging functions for recording curves for quality and RCM events. The DIRIS A80 supplies all the measurements required for energy efficiency projects while its RCM function provides preventative earth leakage information, essential in critical applications to avoid installation shutdowns.

Advantages

Compact

The DIRIS A80 combines two complementary products within a single 96 x 96 mm panel mounted case, enabling faster installation and utilising less space. The DIRIS A80 comprises:

- a multifunction meter with enhanced event logging functions which records curves for quality events.
- an RCM fault current monitoring device (Residual Current Monitoring).

Conformity to standard EN 50160

- EN 50160 is a standard which defines events relating to the quality of electrical networks. The DIRIS A80 captures voltage events in accordance with this standard.

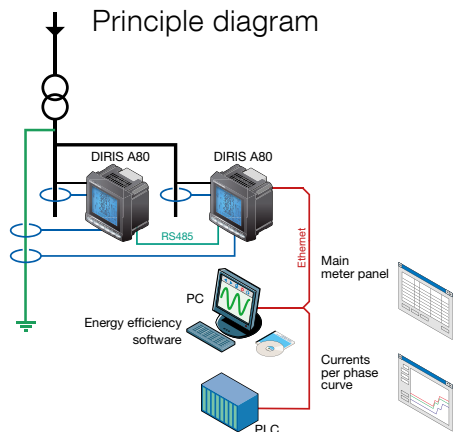

Patent pending

Automatic adjustment of the leakage current alarm threshold in accordance with the load current to avoid false alarms.

Compliant with IEC 61557-12.

IEC 61557-12 is a high-level standard for all PMDs (Performance Monitoring Devices) that are designed to measure and monitor electrical parameters in distribution networks. Compliance with IEC 61557-12 ensures a high level of equipment performance, in terms of metrology, and the mechanical and environmental aspects (EMC, temperature, etc.).

The solution for

- > Industry
- > Infrastructure
- > Health care buildings
- > Data centre

Strong points

- > Compact
- > Patent pending
- > Management softwares
- > Compliant with IEC 61557-12
- > Conformity to standard EN 50160

Conformity to standards

- > IEC 62053-22 class 0.5S
- > IEC 62053-23 class 2
- > IEC 61557-12
- > IEC 62020
- > EN 50160



Management softwares

- Optional Ethernet module with Webservice function: For measurement monitoring, data exploitation and the export of load curves remotely without a specific software (web browser access).
- Analysis software: For the analysis of events data in order to improve the reliability of the electrical installation.
- Easy Config software: For quick and easy remote device configuration; configuration files can be copied from and sent to the DIRIS A80, or they can be created without communication and sent at a later time. Multiple devices can be configured from a single file, which is especially useful for OEMs and panel builders.

Functions

The DIRIS A80 offers the following functions:

- The monitoring of fault currents
- (Residual Current Monitoring)
- Multi-measurement (current, voltage, frequency, power, ...)
- Energy metering
- Harmonic analysis
- Event detection

Fault currents (RCM)

- Measurement of currents $I_{\Delta n}$ ($I_1+I_2+I_3+I_n$) and IPE (protection conductor)
- Permanent monitoring of $I_{\Delta n}$ and IPE
 - Fault current alarms depending on the load current
 - Record of events $I_{\Delta n}$ and IPE (time, duration and curves stored)
 - Alarm report output

Multi-measurement

- Currents
 - instantaneous: $I_1, I_2, I_3, I_n, I_{system}$,
 - average/maximum average: I_1, I_2, I_3, I_n ,
 - unbalance: I_{unb}
- Voltages & frequency
 - instantaneous: $V_1, V_2, V_3, U_{12}, U_{23}, U_{31}, F, V_{system}, U_{system}$
 - average/maximum average: $V_1, V_2, V_3, U_{12}, U_{23}, U_{31}, F$
 - unbalance: U_{unb}
- Power
 - instantaneous: $3P, \Sigma P, 3Q, \Sigma Q, 3S, \Sigma S$
 - maximum average: $\Sigma P, \Sigma Q, \Sigma S$
 - predictive: $\Sigma P, \Sigma Q, \Sigma S$
 - storing of load curves (60 days with an interval of 10 minutes) for the active, reactive and apparent power: $\Sigma P+/-; \Sigma Q+/-; \Sigma S$

- Power factor $PF, \Sigma PF$
- Instantaneous total tangent phi
- Instantaneous, average and max. average unbalance

Metering

- Active energy: +/- kWh
- Reactive energy: +/- kvarh
- Apparent power: kVAh
- Hours \odot

Harmonic analysis (level 63)

- Total harmonic distortion
 - Currents: $thd I_1, thd I_2, thd I_3, thd I_n$
 - Phase-to-neutral voltage: $thd V_1, thd V_2, thd V_3$
 - Phase-to-phase voltage: $thd U_{12}, thd U_{23}, thd U_{31}$.
- Individual
 - Currents: HI_1, HI_2, HI_3, HI_n
 - Phase-to-neutral voltage: HV_1, HV_2, HV_3
 - Phase-to-phase voltage: $HU_{12}, HU_{23}, HU_{31}$.

Events

- Alarms on all electrical values
- Detection and storing of the last 60 events:
 - overvoltage
 - voltage dips
 - cut-offs
 - overloads.

For each stored event, the DIRIS A80 records the relevant RMS 10 ms interval curves for the voltages $V_1, V_2, V_3, U_{12}, U_{23}, U_{31}$, the currents I_1, I_2, I_3 and I_n . These curves can be synchronised with the event curves $I_{\Delta n}$ and IPE.

Communications⁽¹⁾

- RS485 MODBUS RTU
- Ethernet (MODBUS TCP or MODBUS RTU over TCP and Webservice)
- Ethernet (MODBUS TCP or MODBUS RTU over TCP and Webservice) with RS485 MODBUS RTU gateway

⁽¹⁾ Available as an option (see the following pages).

Front panel



1. Backlit LCD display.
2. Direct access key for the currents, RCM function and alarm reset.
3. Direct access key for voltages and frequency.
4. Direct access key for active, reactive, and apparent powers and power factor.
5. Direct access key for maximum and average current, voltage and power values.
6. Direct access key for harmonic values and the connection and RCM test functions.
7. Direct access key for energies, hour meter and programming menu.

Accessories

Core balance transformer ΔIC
(see page 636)



Plug-in modules

DIRIS® A80



Communication MODBUS®

- RS485 link with MODBUS® protocol (speed up to 38400 bauds).

Ethernet communication

- Ethernet connection with MODBUS TCP or MODBUS RTU over TCP protocol.
- Embedded Webserver function⁽¹⁾.

Ethernet communication with RS485 MODBUS gateway

- Ethernet connection with MODBUS TCP or MODBUS RTU over TCP protocol.
- Connection of 1 to 247 RS485 MODBUS slaves.
- Embedded Webserver function⁽¹⁾.

⁽¹⁾ See "Management softwares for DIRIS" page 618.

Terminals

DIRIS A80

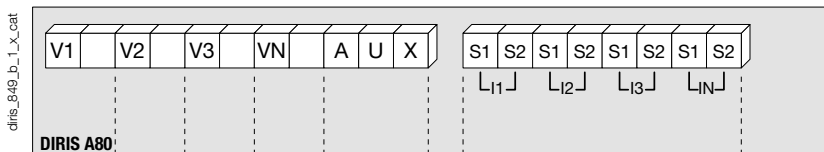

S1 - S2: current inputs

AUX: Auxiliary power supply U_s

V1 - V2 - V3 - VN: voltage inputs

RCM module

1 input / 1 output

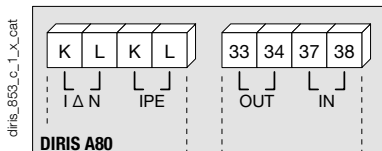

- K-L / IΔN: residual current
K-L / IPE: ground fault current
33-34: relay outputs
37-38: opto inputs

RCM module

2 outputs

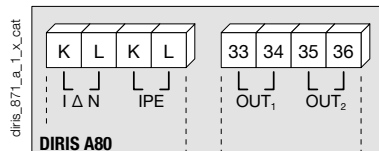

- K-L / IΔN: residual current
K-L / IPE: ground fault current
33-34: relay output n°1
35-36: relay output n°2

Memory module

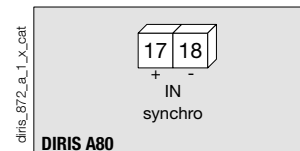

Ethernet module

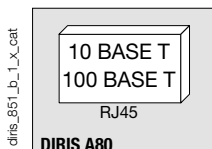

Ethernet module + RS485 MODBUS gateway

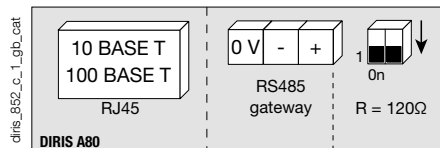

- RS485 gateway resistor.
R = 120 Ω: selectable internal resistance for RS485 end of line termination.

RS485 MODBUS module

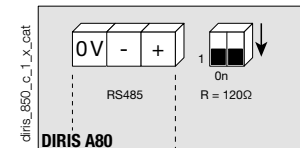

- RS485 link
R = 120 Ω: selectable internal resistance for RS485 end of line termination.

DIRIS A80

Multifunction meters - PMD + RCM

monitoring energy and fault currents - dimensions 96 x 96 mm

Connections

Additional information

Communication via RS485 link

diris_398_c_1_x_cat

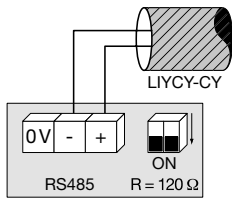

Connection of voltage transformer for HV networks

diris_399_b_1_x_cat

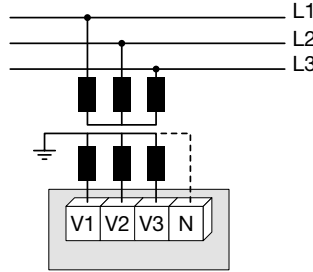

AC & DC auxiliary power supply

diris_400_L_1_gb_cat

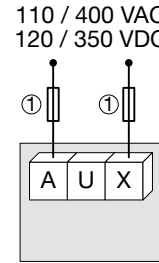

1. Fuses 0.5 A gG / 0.5 A class CC.

Three-phase + N network with RCM

diris_873_a_1_gb_cat

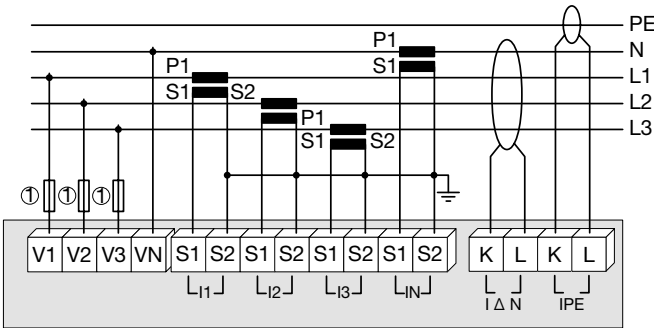

1. Fuses 0.5 A gG / 0.5 A class CC.

Single-phase network with RCM

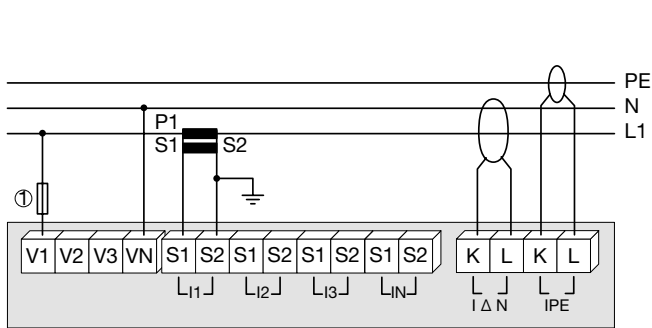

1. Fuses 0.5 A gG / 0.5 A class CC.

Electrical characteristics

Current measurement on insulated inputs (TRMS)	
Via CT primary	9 999 A
Via CT secondary	1 or 5 A
Measurement range	0 ... 11 kA
Input consumption	≤ 0.1 VA
Measurement updating period	1 s
Accuracy	0.2 %
Permanent overload	6 A
Intermittent overload	10 I _n for 1 s
Voltage measurements (TRMS)	
Direct measurement between phases	50 ... 700 VAC
Direct measurement between phase and neutral	28 ... 404 VAC
VT primary	500 000 VAC
VT secondary	60, 100, 110, 173, 190 VAC
Frequency	50 / 60 Hz
Input consumption	≤ 0.1 VA
Measurement updating period	1 s
Accuracy	0.2 %
Permanent overload	800 VAC
Current-voltage product	
Limitation for 1A CT	10 000 000
Limitation for 5A CT	10 000 000
Power measurement	
Measurement updating period	1 s
Accuracy	0.5 %
Power factor measurement	
Measurement updating period	1 s
Accuracy	0.5 %
Frequency measurement	
Measurement range	45 ... 65 Hz
Measurement updating period	1 s
Measurement updating period	0.1 %
Energy accuracy	
Active (according to IEC 62053-22)	Class 0.5 S
Reactive (according to IEC 62053-23)	Class 2
Operating conditions	
Operating temperature	- 10 ... + 55 °C
Storage temperature	- 20 ... + 85 °C
Relative humidity	95 %

Auxiliary power supply	
Alternating voltage	110 ... 400 VAC
AC tolerance	± 10 %
Direct voltage	120 ... 350 VDC
DC tolerance	± 20 %
Frequency	50 / 60 Hz
Consumption	≤ 10 VA
MODBUS communication module	
Link	RS485
Type	2 ... 3 half duplex wires
Protocol	MODBUS® RTU
MODBUS® speed	4800 ... 38400 bauds
Ethernet Communication Module	
Connection	RJ45
Speed	10 base T / 100 base T
Protocol	MODBUS TCP or MODBUS RTU over TCP
Fault current monitoring characteristics (I _{Δn} and I _{PE})	
Inputs I _{Δn} and I _{PE}	
Number of inputs	2
Dedicated core balance transformers	range ΔIC – transformer ratio 600/1
Measurement of fault current I _{Δn} / I _{PE}	6 mA ... 30 A
Accuracy	1 %
Alarms I _{Δn} and I _{PE}	
Thresholds	adjustment depending on the load currents
Time setting	0 to 10 s
Logging	values, dates, durations and curves
Number of events	max. 1000 events
Optocoupler input	
Number	specific to the reference
Power supply	5 ... 24 VDC
Minimum signal width	10 ms
Minimum duration between 2 pulses	20 ms
Type	optocoupler
Alarm outputs	
Number of relays	specific to the reference
Type	230 VAC – 1 A
Max. N° of operations	10 ⁴

Case

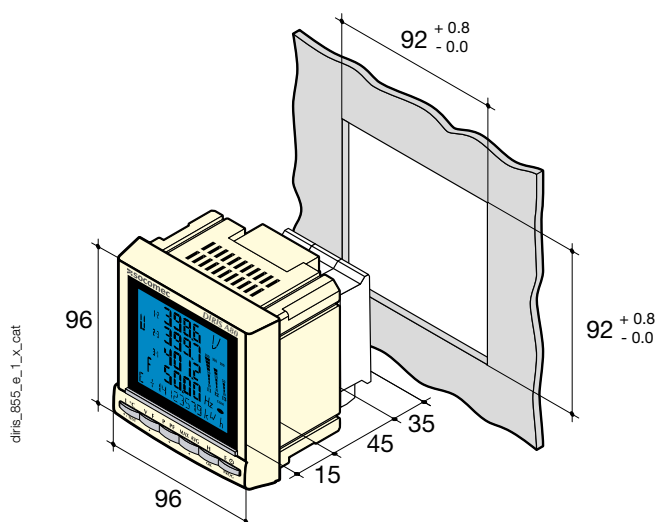

Type	panel mounting
Dimensions W x H x D	96 x 96 x 80 mm
Case degree of protection	IP30
Front degree of protection	IP52
Display type	backlit LCD display
Terminal blocks type	fixed or plug-in
Current connection cross-section	0.5 ... 6 mm ²
Cable cross-section for currents ΔI_n and I_{PE}	0.14 ... 1.5 mm ²
Voltage and other connection cross-section	0.2 ... 2.5 mm ²
Weight	560 g

References

Basic device	DIRIS A80
Type	Reference
With 2 outputs	4825 0213
With 1 input / 1 output	4825 0214
Options	
Plug-in modules	Reference
RS485 MODBUS [®] communication	4825 0092
Ethernet communication (embedded Ethernet Webserver) ⁽¹⁾	4825 0203
Ethernet communication + RS485 MODBUS gateway (embedded Ethernet Webserver) ⁽¹⁾	4825 0204

(1) Dimensions: 2 slots.

Accessories	To be ordered in multiples of	Reference
Description of accessories		
IP65 protection	1	4825 0089
Panel mounting kit for a 144 x 96 mm cut-out	1	4825 0088
Fuse disconnect switches for the protection of voltage inputs (type RM) 3 poles	4	5601 0018
Fuse disconnect switches for the protection of the auxiliary supply (type RM) 1 pole + neutral	6	5601 0017
Fuses type gG 10 x 38 0.5 A	10	6012 0000
Ferrite to be associated with communication modules	1	4899 0011
Current transformer range	1	see page 584

Core balance transformer $\Delta I C$	Toroid diameter (mm)	Reference
Type		
$\Delta I C \text{ } \varnothing 15$	15	4950 6015
$\Delta I C \text{ } \varnothing 30$	30	4950 6030
$\Delta I C \text{ } \varnothing 50$	50	4950 6050
$\Delta I C \text{ } \varnothing 80$	80	4950 6080
$\Delta I C \text{ } \varnothing 120$	120	4950 6120
$\Delta I C \text{ } \varnothing 200$	200	4950 6200
$\Delta I C \text{ } \varnothing 300$	300	4950 6300
Management softwares for DIRIS		see page 618

Expert Services

- > Study, definition, advice, implementation, maintenance and training... Our experts "Expert Services" offer complete support for the success of your project.

